

SABER BAR 6

user manual

©2019 ADJ PRODUCTS LLC all rights reserved. Information, specifications, diagrams, images, and instructions herein are subject to change without notice. ADJ logo and identifying product names and numbers herein are trademarks of ADJ PRODUCTS LLC. Copyright protection claimed includes all forms and matters of copyrightable materials and information now allowed by statutory or judicial law or hereinafter granted. Product names used in this document may be trademarks or registered trademarks of their respective companies and are hereby acknowledged. All non-ADJ brands and product names are trademarks or registered trademarks of their respective companies.

ADJ PRODUCTS LLC and all affiliated companies hereby disclaim any and all liabilities for property, equipment, building, and electrical damages, injuries to any persons, and direct or indirect economic loss associated with the use or reliance of any information contained within this document, and/or as a result of the improper, unsafe, insufficient and negligent assembly, installation, rigging, and operation of this product.

ADJ PRODUCTS LLC USA

6122 S. Eastern Ave. Los Angeles, CA 90040
323-582-2650 | Fax 323-532-2941 | www.adj.com | info@adj.com

ADJ SUPPLY Europe B.V

Junostraat 2 6468 EW Kerkrade, The Netherlands
+31 (0)45 546 85 00 | Fax +31 45 546 85 99 | www.adj.eu | info@americandj.eu

ADJ PRODUCTS GROUP Mexico

AV Santa Ana 30 Parque Industrial Lerma, Lerma, Mexico 52000
+52 (728) 282-7070 | ventas@adj.com

Energy Saving Matters (EuP 2009/125/EC)

Saving electric energy is a key to help protecting the environment. Please turn off all electrical products when they are not in use. To avoid power consumption in idle mode, disconnect all electrical equipment from power when not in use. Thank you!

DOCUMENT VERSION

An updated version of this document may be available online.

Please check www.adj.com for the latest revision/update of this document before beginning installation and use.

Date	Document Version	Software Version	Notes
6/5/19	1	≥ 1.01	Initial release.

CONTENTS

General Information	4
Limited Warranty (USA Only)	5
Safety Guidelines	6
Maintenance Guidelines	8
Fixture Overview	9
DMX Setup	11
Installation Instructions	13
System Menu	14
DMX Channels / Values / Functions	18
Dimmer Curve Chart	22
Remote Operating Instructions	23
Multiple Unit Power Linking	24
Master / Slave Set up	24
Optional Lens / Fuse Replacement / Cleaning	24
Trouble Shooting Tips and FAQ	25
Technical Specifications and Optional Accessories	26
Dimensions	27

GENERAL INFORMATION

INTRODUCTION

Please read and understand all instructions in this manual carefully and thoroughly before attempting to operate these products. These instructions contain important safety and use information.

UNPACKING

The products in this kit have been thoroughly tested and have been shipped in perfect operating condition. Carefully check the shipping carton for damage that may have occurred during shipping. If the carton appears to be damaged, carefully inspect each unit included for damage and be sure all accessories necessary to operate the units have arrived intact. In the event damage has been found or parts are missing, please contact our customer support team for further instructions. Please do not return this kit to your dealer without first contacting customer support at the number listed below. Please do not discard the shipping carton in the trash. Please recycle whenever possible.

WARRANTY RETURNS

All returned service items whether under warranty or not, must be freight pre-paid and accompany a return authorization (R.A.) number. The R.A. number must be clearly written on the outside of the return package. A brief description of the problem as well as the R.A. number must also be written down on a piece of paper and included in the shipping container. If the unit is under warranty, you must provide a copy of your proof of purchase invoice. Items returned without a R.A. number clearly marked on the outside of the package will be refused and returned at customer's expense. You may obtain a R.A. number by contacting customer support.

CUSTOMER SUPPORT

Contact ADJ Service for any product related service and support needs. Please visit forums.adj.com with questions, comments or suggestions.

ADJ SERVICE USA - Monday - Friday 8:00am to 4:30pm PST
800-322-6337 | Fax 323-832-2941 | support@adj.com

ADJ SERVICE EUROPE - Monday - Friday 08:30 to 17:00 CET
+31 45 546 85 60 | Fax +31 45 546 85 96 | support@adj.eu

REPLACEMENT PARTS please visit parts.adj.com

FCC RADIO FREQUENCY INTERFERENCE WARNINGS & INSTRUCTIONS

This product has been tested and found to comply with the limits as per Part 15 of the FCC Rules. These limits are designed to provide reasonable protection against harmful interference in a residential installation. This device uses and can radiate radio frequency energy and, if not installed and used in accordance with the included instructions, may cause harmful interference to radio communications. However, there is no guarantee that interference will not occur in a particular installation. If this device does cause harmful interference to radio or television reception, which can be determined by turning the device off and on, the user is encouraged to try to correct the interference by one or more of the following methods:

- Reorient or relocate the device.
- Increase the separation between the device and the receiver.
- Connect the device to an electrical outlet on a circuit different from which the radio receiver is connected.
- Consult the dealer or an experienced radio/TV technician for help.

LIMITED WARRANTY (USA ONLY)

- A. ADJ Products, LLC hereby warrants, to the original purchaser, ADJ Products, LLC products to be free of manufacturing defects in material and workmanship for a prescribed period from the date of purchase (see specific warranty period on reverse). This warranty shall be valid only if the product is purchased within the United States of America, including possessions and territories. It is the owner's responsibility to establish the date and place of purchase by acceptable evidence, at the time service is sought.
- B. **For warranty service, you must obtain a Return Authorization number (RA#) before sending back the product-please contact ADJ Products, LLC Service Department at 800-322-6337.** Send the product only to the ADJ Products, LLC factory. All shipping charges must be pre-paid. If the requested repairs or service (including parts replacement) are within the terms of this warranty, ADJ Products, LLC will pay return shipping charges only to a designated point within the United States. If the entire instrument is sent, it must be shipped in its original package. No accessories should be shipped with the product. If any accessories are shipped with the product, ADJ Products, LLC shall have no liability whatsoever for loss of or damage to any such accessories, or for the safe return thereof.
- C. This warranty is void if the serial number has been altered or removed; if the product is modified in any manner which ADJ Products, LLC concludes, after inspection, affects the reliability of the product, if the product has been repaired or service by anyone other than ADJ Products, LLC factory unless prior written authorization was issued to purchaser by ADJ Products, LLC; if the product is damaged because not properly maintained as set forth in the instruction manual.
- D. This is not a service contract, and this warranty does not include maintenance, cleaning or periodic check up. During the period specified above, ADJ Products, LLC will replace defective parts at its expense with new or refurbished parts, and will absorb all expenses for warrant service and repair labor by reason of defects in material or workmanship. The sole responsibility of ADJ Products, LLC under this warranty shall be limited to the repair of the product, or replacement thereof, including parts, at the sole discretion of ADJ Products, LLC. All products covered by this warranty were manufactured after August 15, 2012, and bear identifying marks to that effect.
- E. ADJ Products, LLC reserves the right to make changes in design and/or improvements upon its products without any obligation to include these changes in any products theretofore manufactured.
- F. No warranty, whether expressed or implied, is given or made with respect to any accessory supplied with products described above. Except to the extent prohibited by applicable law, all implied warranties made by ADJ Products, LLC in connection with this product, including warranties of merchantability or fitness, are limited in duration to the warranty period set forth above. And no warranties, whether expressed or implied, including warranties of merchantability or fitness, shall apply to this product after said period has expired. The consumer's and/or Dealer's sole remedy shall be such repair or replacement as is expressly provided above; and under no circumstances shall ADJ Products, LLC be liable for any loss or damage, direct or consequential, arising out of the use of, or inability to use, this product.
- G. This warranty is the only written warranty applicable to ADJ Products, LLC Products and supersedes all prior warranties and written descriptions of warranty terms and conditions heretofore published.

LIMITED WARRANTY PERIODS

- **Non L.E.D. Lighting Products = 1-year (365 days) Limited Warranty** (Such as: Special Effect Lighting, Intelligent Lighting, UV lighting, Strobes, Fog Machines, Bubble Machines, Mirror Balls, Par Cans, Trussing, Lighting Stands etc. excluding LED and lamps)
- **Laser Products = 1 Year (365 Days) Limited Warranty** (excludes laser diodes which have 6 month limited warranty)
- **L.E.D. Products = 2-year (730 days) Limited Warranty** (excluding batteries which have a 180 day limited warranty)
Note: 2 Year Warranty only applies to purchases within the United States.
- **StarTec Series = 1 Year Limited Warranty** (excluding batteries which have a 180 day limited warranty)
- **ADJ DMX Controllers = 2 Year (730 Days) Limited Warranty**

SAFETY INSTRUCTIONS AND GUIDELINES

To guarantee a smooth operation, it is important to follow all instructions and guidelines in this manual. ADJ PRODUCTS LLC is not responsible for injury and/or damages resulting from the misuse of these devices due to the disregard of the information printed in this manual. Only qualified and/or certified personnel should perform installation of these devices and only the original rigging parts included with these devices should be used for installation. Any modifications to these devices and/or the included mounting hardware will void the original manufactures warranty and increase the risk of damage and/or personal injury.



PROTECTION CLASS 1 – DEVICES MUST BE PROPERLY GROUNDED



THERE ARE NO USER SERVICEABLE PARTS INSIDE THESE DEVICES. DO NOT ATTEMPT ANY REPAIRS YOURSELF; DOING SO WILL VOID YOUR MANUFACTURES WARRANTY. DAMAGES RESULTING FROM MODIFICATIONS TO THESE DEVICES AND/OR THE DISREGARD OF SAFETY INSTRUCTIONS AND GUIDELINES IN THIS MANUAL VOID THE MANUFACTURES WARRANTY AND ARE NOT SUBJECT TO ANY WARRANTY CLAIMS AND/OR REPAIRS.



**DO NOT PLUG THIS UNIT INTO A DIMMER PACK!
DO NOT REMOVE THE COVER UNDER ANY CONDITIONS!
NEVER OPERATE THIS UNIT WITH THE COVER REMOVED!
UNPLUG POWER DURING LONG PERIODS OF NON-USE
NEVER TOUCH LIGHT DURING OPERATION, AS IT MAY BE HOT!
KEEP FLAMMABLE MATERIALS AWAY FROM THESE DEVICES!**



**INDOOR / DRY LOCATIONS USE ONLY!
DO NOT EXPOSE DEVICES TO RAIN AND/OR MOISTURE!**



**NEVER LOOK DIRECTLY INTO THE LIGHT SOURCE!
RETINA INJURY RISK - MAY INDUCE BLINDNESS!
SENSITIVE PERSONS MAY SUFFER AN EPILEPTIC SHOCK!**

SAFETY INSTRUCTIONS AND GUIDELINES

DO NOT DISCONNECT ANY OF THE POWER CABLES FROM ANY OF THE 6 FIXTURES WHEN THE BAR IS POWERED ON.

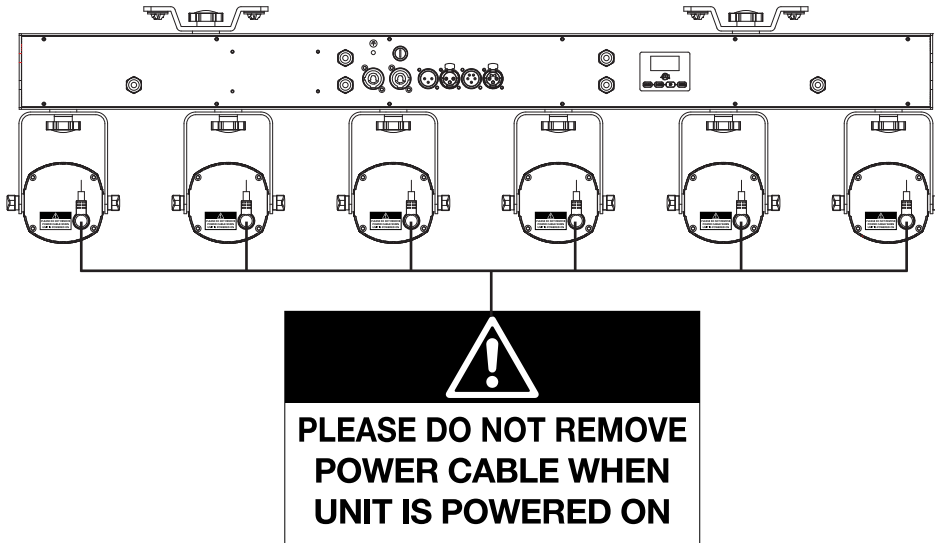

- DO NOT** position devices close to any **FLAMMABLE MATERIALS** while operating.
 - DO NOT** attempt installation and/or operation of devices without knowledge how to do so.
 - DO NOT** permit operation by persons who are not qualified to operate these types of devices.
 - DO NOT** shake devices, avoid brute force when installing and/or operating.
 - DO NOT** operate these devices if the main power cord has become frayed, crimped and/or damaged. Replace any damaged power cords with a similar power rating.
 - DO NOT** remove or break-off the ground plug from the device power cords.
 - DO NOT** remove disassemble devices, there are **NO** user serviceable parts inside.
 - ALWAYS** disconnect devices from main power source before performing any cleaning.
 - ALWAYS** be sure to install these devices in an area that will allow proper ventilation.
 - NEVER** remove the ground prong from the power cable.
- Power cords should be safely routed and secured so they are not likely pinched.
- Disconnect power cords during long periods of non-use.
- Only use recommended rigging hardware as described in this guide.
- Use the original packaging and materials to transport these devices in for service.
- These devices should be serviced by qualified service personnel when:
- The power cords or plugs have become damaged.
 - Objects have fallen on and/or liquid has spilled into the devices.
 - The devices have been exposed to rain and/or moisture.
 - The devices do not operate normally or exhibit a marked change in performance.

MAINTENANCE GUIDELINES



DISCONNECT POWER BEFORE PERFORMING ANY MAINTENANCE!

THERE ARE NO USER SERVICEABLE PARTS INSIDE THESE DEVICES, PLEASE REFER ALL OTHER SERVICE ISSUES TO AN AUTHORIZED ADJ SERVICE CENTER.

CLEANING

Frequent cleaning is recommended to insure proper function, optimized light output, and an extended life. The frequency of cleaning depends on the environment in which the device operates in: damp, smoky or particularly dirty environments can cause greater accumulation of dirt on the lens and/or light fixture optics. Clean the external housing of the fixture and the front lens of the light at least every 30-60 days with a soft cloth to avoid dirt/debris accumulation.

NEVER use alcohol, solvents, or ammonia-based cleaners.

MAINTENANCE

Regular inspections are recommended to insure proper function and extended life.

There are no user serviceable parts inside these devices, please refer all other service issues to an authorized ADJ service technician. Should you need any spare parts, please order genuine parts from your local ADJ dealer.

Please refer to the following points during routine inspections:

A detailed review by an approved electrical engineer every three months, to make sure the circuit contacts are in good condition and prevent overheating.

Be sure all screws and fasteners are securely tightened at all times. Loose screws may fall out during normal operation resulting in damage or injury as larger parts could fall.

Check for any deformations on the light, light housings, lenses, rigging hardware and rigging points (ceiling, suspension, trussing). Deformations could allow for dust to enter into the devices. Damaged rigging points or unsecured rigging could cause the devices to fall and seriously injure a person(s).

Electric power supply cables must not show any damage, material fatigue or sediments.

OVERVIEW

FRONT

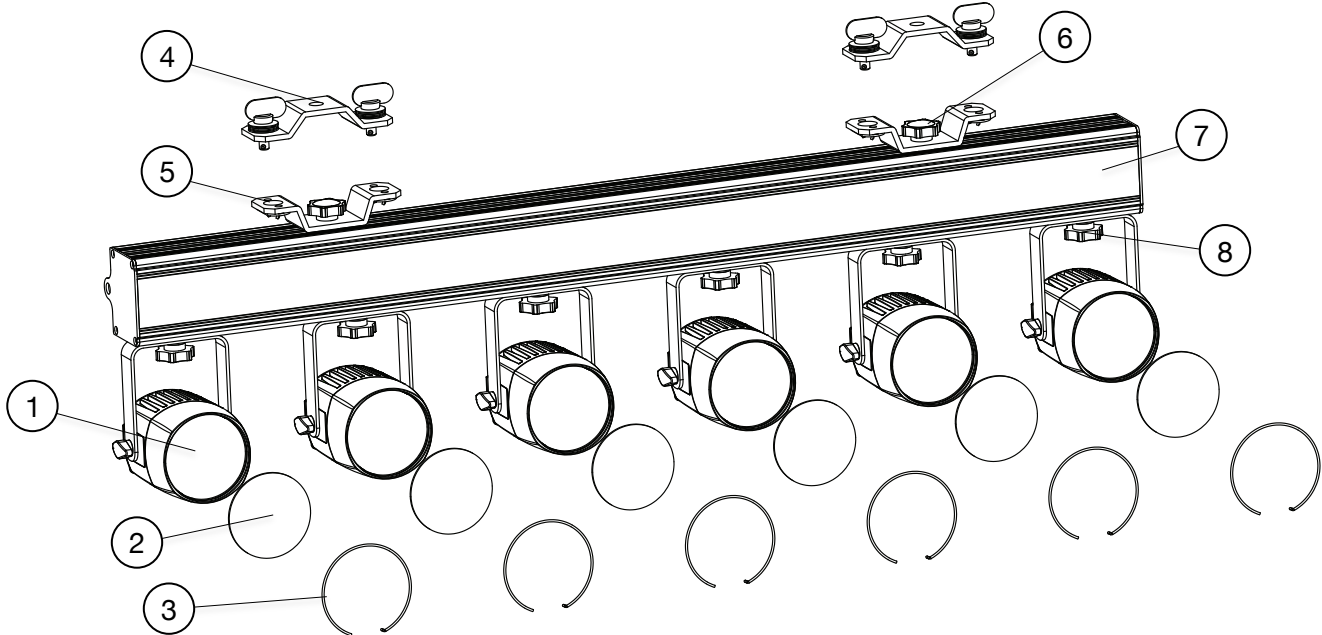

Included items

- 1 – **Saber Spot WW:** 15W Warm White LED (x6)
- 2 – **Frost Filter:** 10° (x6) and 45° Filter (x6)
- 3 – **Filter Retainer Ring:** (x6)
- 4 – **Omega Bracket:** Top (x2)
- 5 – **Omega Bracket:** Bottom (x2)
- 6 – **Bracket Knob:** (x2)
- 7 – **Linear Base:** 1 meter with built-in power and DMX Connections (see next page)
- 8 – **Head Mounting Knob:** (x6)
- 9 – **RF Remote Control:** (Not pictured above.) See page 23 for instructions.
- 10 – **Safety Cable:** (x2) (Not included or pictured above.) See page 13 for instructions.
- 11 – **Power Cable:** (Not pictured above.)

OVERVIEW

REAR

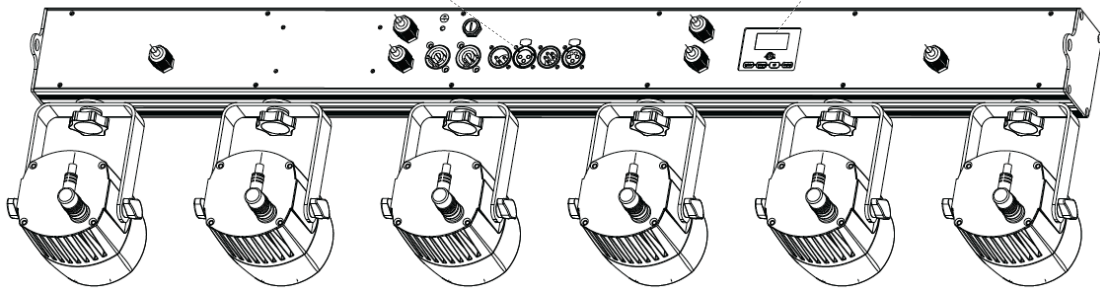
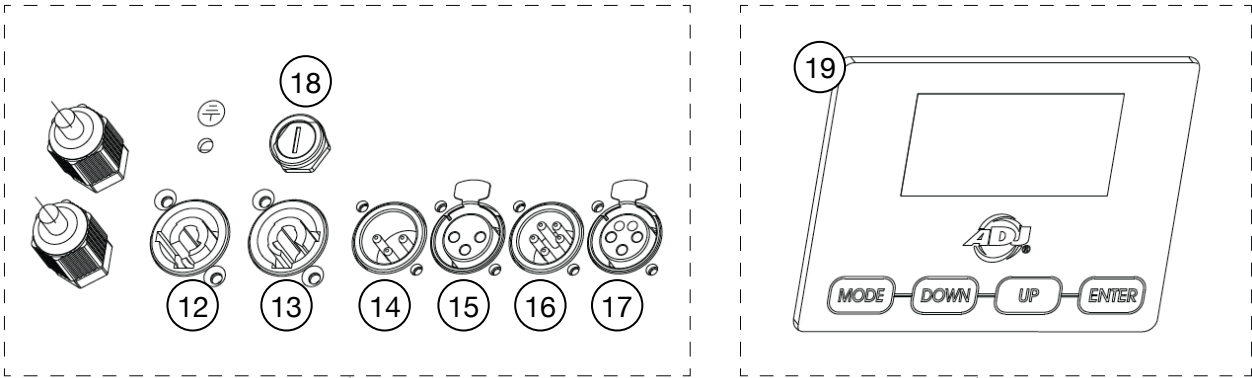

12 – POWER IN

13 – POWER OUT

14 – DMX IN

15 – DMX OUT

16 – DMX IN

17 – DMX OUT

18 – FUSE: T2A/250V

19 – LED Display: Shows the various menus and the selected functions.

MODE	To select the programming functions
UP	To go backward in the selected functions
DOWN	To go forward in the selected functions
ENTER	To go forward or select a function

DMX SETUP

POWER SUPPLY

The Saber Bar 6 contains an automatic voltage switch, which will auto sense the voltage when it is plugged into the power source. With this switch there is no need to worry about the correct power voltage, this unit can be plugged in anywhere.

DMX-512

DMX is short for Digital Multiplex. This is a universal protocol used by most lighting and controller manufactures as a form of communication between intelligent fixtures and controllers. A DMX controller sends DMX data instructions from the controller to the fixture. DMX data is sent as serial data that travels from fixture to fixture via the DATA “IN” and DATA “OUT” XLR terminals located on all DMX fixtures (most controllers only have a DATA “OUT” terminal).

DMX LINKING

DMX is a language allowing all makes and models of different manufactures to be linked together and operate from a single controller, as long as all fixtures and the controller are DMX compliant. To ensure proper DMX data transmission, when using several DMX fixtures try to use the shortest cable path possible. The order in which fixtures are connected in a DMX line does not influence the DMX addressing. For example, a fixture assigned a DMX address of 1 may be placed anywhere in a DMX line, at the beginning, at the end, or anywhere in the middle. Therefore, the first fixture controlled by the controller could be the last fixture in the chain. When a fixture is assigned a DMX address of 1, the DMX controller knows to send DATA assigned to address 1 to that unit, no matter where it is located in the DMX chain.

DATA CABLE (DMX CABLE) REQUIREMENTS (FOR DMX AND MASTER/SLAVE OPERATION):

The Saber Bar 6 can be controlled via DMX-512 protocol. The Saber Bar 6 has 8 DMX channel modes (1, 3, 4, 6, 9, 10, 12 and 13 channel mode). The DMX address is set electronically using the controls on the rear panel of the unit. Your unit and your DMX controller require an approved DMX-512 110 Ohm Data cable for data input and data output (Figure 1). We recommend AccuCable DMX cables. If you are making your own cables, be sure to use standard 110-120 Ohm shielded cable (This cable be purchased at almost all professional sound and lighting stores). Your cables should be made with a male and female XLR connector on either end of the cable. Also remember that DMX cable must be daisy chained and cannot be split.



Figure 1

DMX SETUP

NOTICE

Be sure to follow figures two and three when making your own cables. Do not use the ground lug on the XLR connector. Do not connect the cable's shield conductor to the ground lug or allow the shield conductor to come in contact with the XLR's outer casing. Grounding the shield could cause a short circuit and erratic behavior.

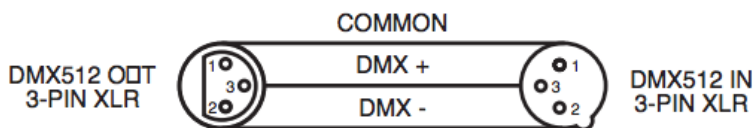

Figure 2

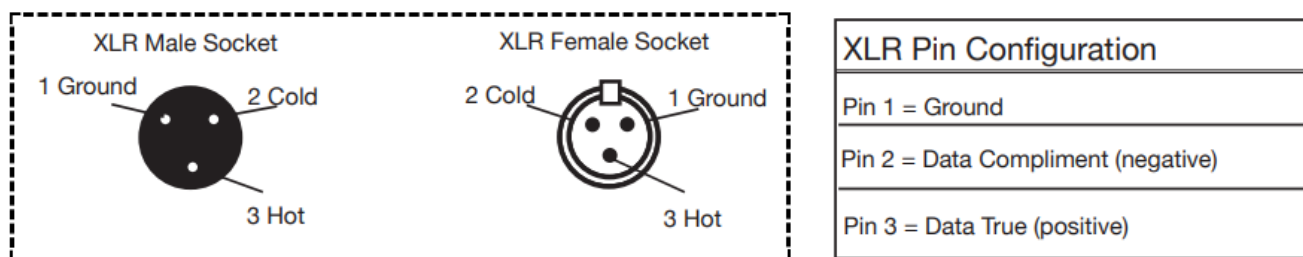

Figure 3

SPECIAL NOTE: LINE TERMININATION

When longer runs of cable are used, you may need to use a terminator on the last unit to avoid erratic behavior. A terminator is a 110-120 ohm 1/4 watt resistor, which is connected between pins 2 and 3 of a male XLR connector (DATA + and DATA -). This unit is inserted in the female XLR connector of the last unit in your daisy chain to terminate the line. Using a cable terminator (ADJ part number Z-DMX/T) will decrease the possibilities of erratic behavior.

Figure 4

DMX512 IN
3-PIN XLR

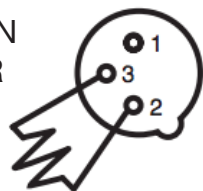

Termination reduces signal errors and avoids signal transmission problems and interference. It is always advisable to connect a DMX terminal, (Resistance 120 Ohm 1/4 W) between PIN 2 (DMX-) and PIN 3 (DMX +) of the last fixture.

INSTALLATION INSTRUCTIONS

INSTALLATION

This unit should be mounted using a mounting clamp (not provided), affixing it to the mounting bracket that is provided with the unit. Always ensure that the unit is firmly fixed to avoid vibration and slipping while operating. Always ensure that the structure to which you are attaching the unit is secure and is able to support the weight of ten (10) times the unit's weight and any mounting accessories. Safety cables (not included) are recommended when installing the fixture. It is also recommended that a professional installs the equipment and it must be installed in a place where it is out of the reach of people's grasp.

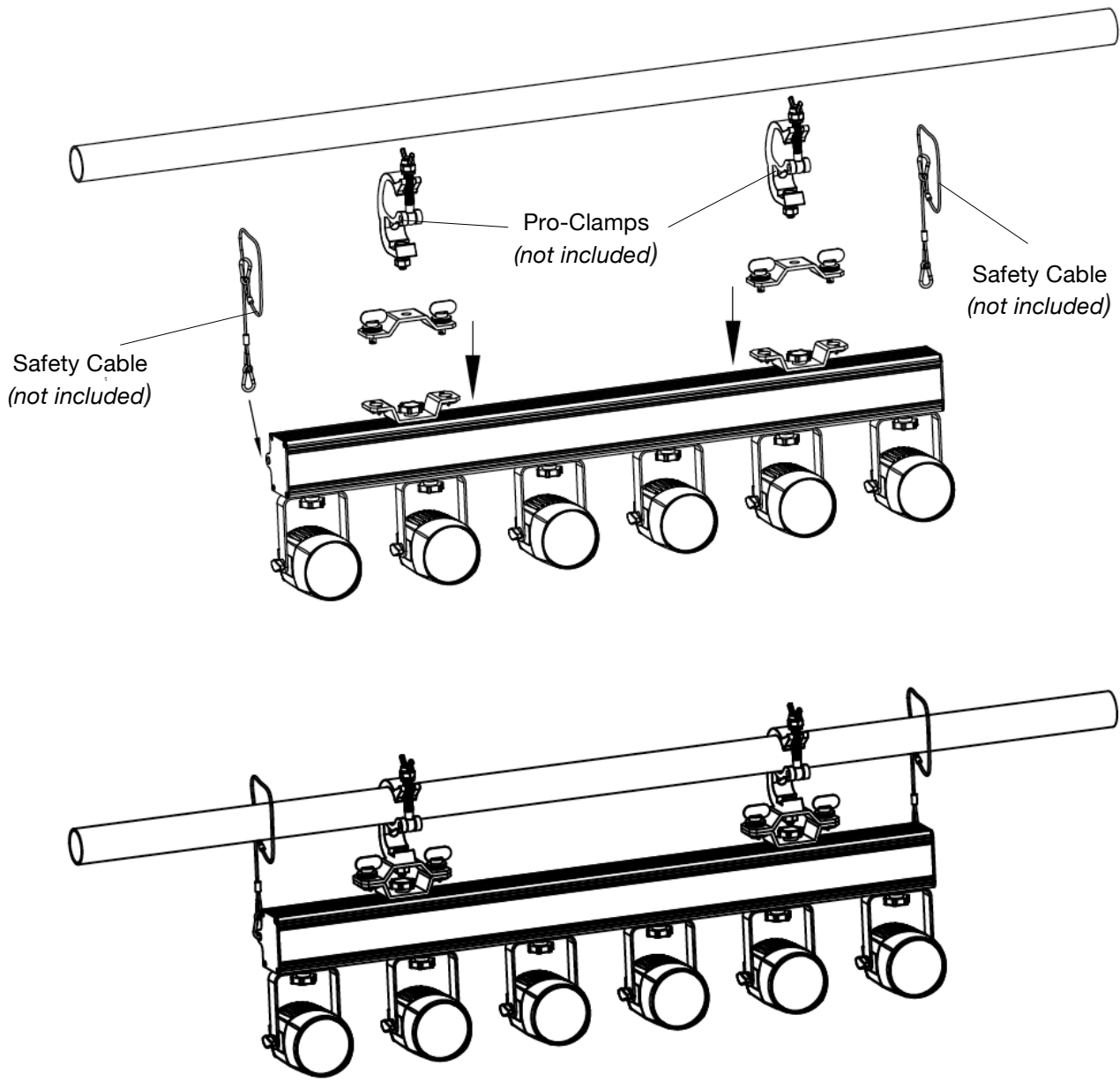

SYSTEM MENU

System Menu				
Supports Software Versions \geq 1.01				
<i>Features are subject to change without any prior written notice</i>				
Menu	Sub Menu	Options/Values (Default settings in BOLD)		Description
MENU Address	Set ADDR 001	001-507		
MENU Mode	UserMode	1/3/4/6/9/10/12 and 13CH		
MENU Function	No DMX	Hold/Black/Program		
	LCD. Set	Display Key Lock Flash Inverse	ON/OFF ON/ON1/OFF ON/OFF OFF/ON	
	Temp. C/F	C/F		
	Dim Mode	Standard Stage TV Architec Theatre Stage 2		
	MasterSw	On/Off		
	DimCurve	Linear/Square/INV.Squa/ S-Curve		
	Frequen	900HZ , 1000HZ, 1100HZ, 1200HZ, 1300HZ, 1400HZ, 1500HZ, 2500HZ, 4000HZ, 5000HZ, 10kHz, 15kHz, 20kHz, 25kHz		
	Flip	Standard/Flip		
	RFActive	On/Off		
	Defaults	Reset? / Cancel		Factory default set

Standard

1	2	3	4	5	6
---	---	---	---	---	---

Flip

6	5	4	3	2	1
---	---	---	---	---	---

SYSTEM MENU

System Menu			
Supports Software Versions \geq 1.01			
<i>Features are subject to change without any prior written notice</i>			
Menu	Sub Menu	Options/Values (Default settings in BOLD)	Description
MENU Info	TimeInfo	Current Total Last Password Clear	Current fixture running time (H) Fixture total running time (H) Last clear fixture running time (H) Clear 0: (Password = 050/060) ON/OFF
	TempInfo	XXX C/F	
	Err. Info	None / Temp 1	
	ModelInf	Saber Bar 6	
	Software	1UV1.01 2UV1.01	
MENU Manual	Dimmer/Dim Fine	000-255	
	White1/White2/White3/ White4/White5/White6/ Strobe	000-255	
MENU Program	Program	Flow	1-13
	Speed	000-255	
	Fade Strobe	000-255	
MENU Slave	Slave		
MENU Calibrat	Calibrat Password	000-255	White balance (Password = 050)
	White1/White2/White3/ White4/White5/White6		

SYSTEM MENU

LCD CONTROL PANEL LOCKOUT

When **Key Lock** menu is set to ON, the LCD backlight will turn OFF after 30 seconds and the Control Panel will lock and the display will show **LOCKED*******.

Press and hold the **MODE** button for 5 seconds to unlock.

When **Key Lock** menu is set to **ON1**, the LCD backlight will turn OFF after 30 seconds and the Control Panel will lock and the display will show **LOCKED*******.

To unlock the Control Panel, follow these steps:

1. When locked, the display will show: **LOCKED*******
2. Press **UP**, then the display will change to: **LOCKED****** (one * disappears)
3. Press **DOWN**, then the display will change to: **LOCKED***** (two * disappear)
4. Press **UP**, then the display will change to: **LOCKED**** (three * disappear)
5. Press **DOWN**, then the display will change to: **LOCKED*** (four * disappear)
6. Press **ENTER**, then the display will change to **LOCKED** and then become unlocked.

DMX Mode: Operating through a DMX controller gives the user the freedom to create their own programs tailored to their own individual needs. See pages 18-21 for each mode's DMX traits. Press the **MODE** button to select the DMX mode.

MENU Addressing and MENU Mode: This function will allow you to control each individual fixture's traits with a standard DMX 512 controller.

1. To run your fixture in DMX mode press the **MODE** button until MENU Address is displayed and press **ENTER**. "Set ADDR XXX" represents the current displayed DMX address.
2. Use the **UP** or **DOWN** buttons to select your desired DMX address, then press the **ENTER** button to select your DMX Channel mode.
3. Use the **UP** or **DOWN** button to scroll through the DMX Channel modes (1CH, 3CH, 4CH, 6CH, 9CH, 10CH, 12CH, and 13CH).

MENU Function:

No DMX Setup: This mode allows the unit to default to one of three modes if the DMX signal is lost or interrupted.

1. Press the **ENTER** button to select your setting.
2. Press the **UP** or **DOWN** button to select one of the three options.
 - HOLD** = the unit will hold the last state before the signal was lost.
 - BLACK** = if the DMX signal is lost or interrupted, the unit will automatically go into stand by mode.
 - PROGRAM** = the unit will run the default internal programs.

SYSTEM MENU

MENU Function: (continued)

- LCD Set:** This mode allows the user to select display options, key lock, flash and display inverse.
- Temp. C/F:** This mode allows the unit to display the current temperature in Celsius or Fahrenheit.
- Dim Mode:** The Dim Mode allows you to select one of the following preset dimming modes: See page 22 for dimming curve chart.
- MasterSW:** This mode allows the user to turn ON/OFF the DMX signal output when in Master Mode.
- DimCurve:** This mode allows the user to select one of four dimmer curve options.
- Frequen:** This mode allows the user to select the desired frequency/flicker.'
- Flip:** This mode allows the lighting to be sequenced 1,2,3,4,5,6 (standard) to 6,5,4,3,2,1 (flip).
- RFActive:** This mode allows you to disable or enable the RF remote feature.
- Defaults:** This option allows you to reset the functions to factory default.

MENU Info:

- Time Info:** This mode lets the user choose to display Current, Total, or running time since the Last reset.
- Current =** Displays the current fixture's running time in hours.
- Total =** Displays the fixture's total running time in hours.
- Last =** Displays the fixture's running time (in hours) since the last clear/reset.
- Password =** Clear 0: (password = 050/060)
- Clear =** Reset the fixture's Last running time.
- TempInfo:** Displays the current temperature of the unit (Celsius or Fahrenheit).
- Err. Info:** Displays any errors or high temperature.
- Modellnf:** Displays the unit name (Saber Bar 6).
- Software:** Current software version(s).

MENU Manual: Adjust Dimmer or Dimmer Fine, White (1-6) values and Strobe.

MENU Program: Auto Programs 1-13, Speed, Fade and Strobe adjustment.

MENU Slave: This mode allows the user to set the unit to Slave mode.

MENU Calibrat: Calibrate the white balance.

DMX CHANNELS/VALUES/FUNCTIONS

Channel Modes						Value	Function
1Ch	3Ch	4Ch	6Ch	9Ch	10Ch		
1	1	1	1	1	1	0-255	Head 1: 0~100%
1	1	1	2	2	2	0-255	Head 2: 0~100%
1	1	1	3	3	3	0-255	Head 3: 0~100%
1	1	1	4	4	4	0-255	Head 4: 0~100%
1	1	1	5	5	5	0-255	Head 5: 0~100%
1	1	1	6	6	6	0-255	Head 6: 0~100%
		2		7	7	0-31 32-63 64-95 96-127 128-159 160-191 192-223 224-255	Shutter and Strobe Effect LEDs Off LEDs On Strobe effect slow to fast LEDs On Pulse effect in sequences LEDs On Random strobe effect slow to fast LEDs On
	2	3		8	8	0-255	Dimmer (intensity) Intensity 0 to 100%
	3	4		9	9	0-255	Dimmer Fine 16-bit
					10	0-20 21-40 41-60 61-80 81-100 101-120 121-255	Dim Mode Standard Stage TV Architectural Theatre Stage 2 Default to Unit Setting

DMX CHANNELS/VALUES/FUNCTIONS

Channel Mode 10Ch	Value	Function
1	0-255	Head 1: 0~100%
2	0-255	Head 2: 0~100%
3	0-255	Head 3: 0~100%
4	0-255	Head 4: 0~100%
5	0-255	Head 5: 0~100%
6	0-255	Head 6: 0~100%
7	0-31 32-63 64-95 96-127 128-159 160-191 192-223 224-255	Shutter and Strobe Effect LEDs Off LEDs On Strobe effect slow to fast LEDs On Pulse-effect in sequences LEDs On Random strobe effect slow to fast LEDs On
8	0-255	Dimmer (intensity) Intensity 0 to 100%
9	0-255	Dimmer Fine 16-bit
10	0-20 21-40 41-60 61-80 81-100 101-120 121-255	Dim Mode Standard Stage TV Architectural Theatre Stage 2 Default to Unit Setting

DMX CHANNELS/VALUES/FUNCTIONS

Channel Mode 12Ch	Value	Function
1	0-255	Head 1: 0~100%
2	0-255	Head 1 Fine 16-bit
3	0-255	Head 2: 0~100%
4	0-255	Head 2 Fine 16-bit
5	0-255	Head 3: 0~100%
6	0-255	Head 3 Fine 16-bit
7	0-255	Head 4: 0~100%
8	0-255	Head 4 Fine 16-bit
9	0-255	Head 5: 0~100%
10	0-255	Head 5 Fine 16-bit
11	0-255	Head 6: 0~100%
12	0-255	Head 6 Fine 16-bit

DMX CHANNELS/VALUES/FUNCTIONS

Channel Mode 13Ch	Value	Function
1	0-255	Head 1: 0~100%
2	0-255	Head 2: 0~100%
3	0-255	Head 3: 0~100%
4	0-255	Head 4: 0~100%
5	0-255	Head 5: 0~100%
6	0-255	Head 6: 0~100%
7	0-31	Shutter and Strobe Effect LEDs Off
	32-63	LEDs On
	64-95	Strobe effect slow to fast
	96-127	LEDs On
	128-159	Pulse-effect in sequences
	160-191	LEDs On
	192-223	Random strobe effect slow to fast
224-255	LEDs On	
8	0-255	Dimmer (intensity) Intensity 0 to 100%
9	0-255	Dimmer Fine 16-bit

Channel Mode 13Ch	Value	Function
10	0	Auto programs: Off
	1~20	Auto Program 1
	21~40	Auto Program 2
	41~60	Auto Program 3
	61~80	Auto Program 4
	81~100	Auto Program 5
	101~120	Auto Program 6
	121~140	Auto Program 7
	141~160	Auto Program 8
	161~180	Auto Program 9
	181~200	Auto Program 10
	201~220	Auto Program 11
	221~240	Auto Program 12
241~250	Auto Program 13	
251~255	Nothing	
11	0-255	Auto Program Speed: Slow to Fast speed
12	0-255	Auto Programs Fade: Less to More
13	0-20	Dim Mode Standard
	21-40	Stage
	41-60	TV
	61-80	Architectural
	81-100	Theatre
	101-120	Stage 2
121-255	Default to Unit Setting	

DIMMER CURVE CHART

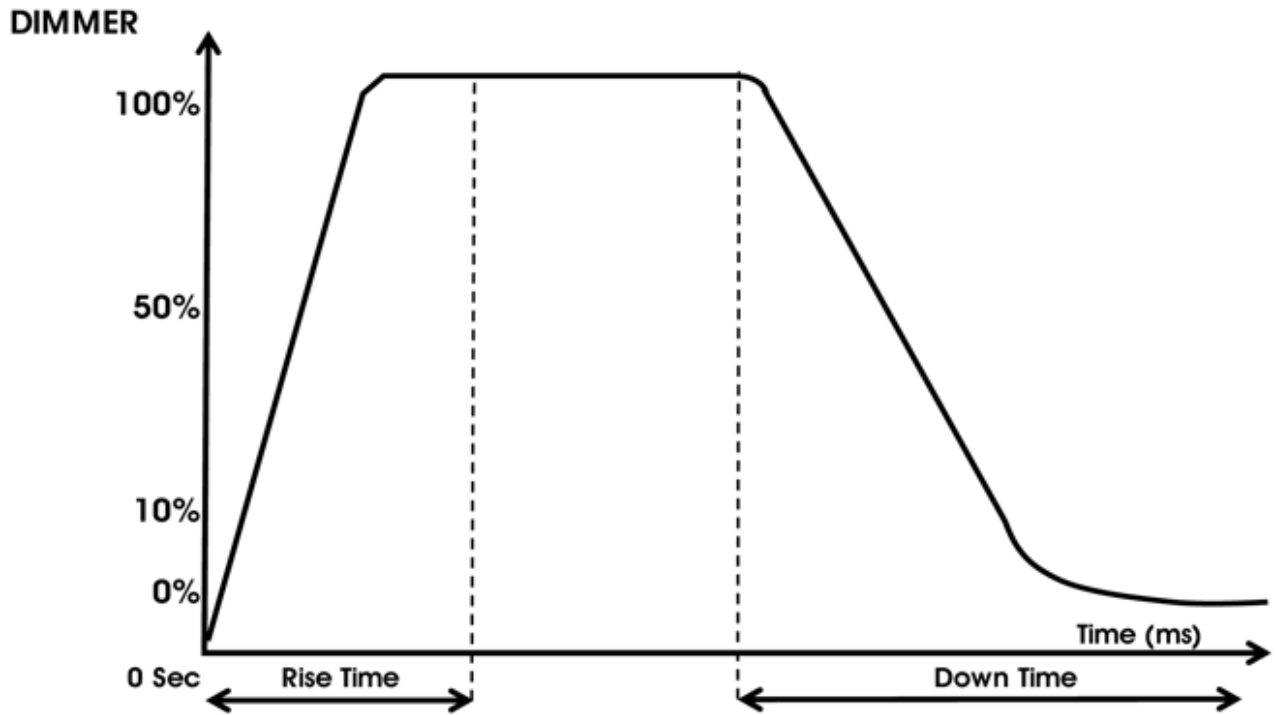

Dimming Curve Ramp Effect	0 sec Fade Time		1 sec Fade Time	
	Rise Time (ms)	Down Time (ms)	Rise Time (ms)	Down Time (ms)
Standard (default)	0	0	0	0
Stage	780	1100	1540	1660
TV	1180	1520	1860	1940
Architectural	1380	1730	2040	2120
Theatre	1580	1940	2230	2280
Stage 2	0	1100	0	1660

REMOTE OPERATING INSTRUCTIONS

RF Remote Control: The Dotz Par RF wireless remote has many different functions and allows you to control a variety of ADJ LED Pars from long distance. The remote can control your Saber Bar 6 up to 75 feet / 25 meters. To use the remote you must first activate the **RFActive** mode on the fixture. To activate the receiver please see the menu and instructions on pages 15-17.

- **Blackout** – Pressing this button will blackout the fixture.
- **Fade** – This button will activate the auto fade program.
- **Color** – This button will activate the dimmer mode. Use the “+” and “-” buttons to scroll through the brightness and find your desired light output.
- **Programs** – This button will activate the built in strobe mode. Use the “+” and “-” buttons to scroll through the strobe frequency.
- **Sound Active** – This button activates the Auto Speed mode. Use the “+” and “-” buttons to scroll through the speed.
- **Auto Run** – This button will run an automatic program. Use the “+” and “-” buttons to adjust the speed of the auto run.
- **“+” And “-”** – Use these buttons to adjust the speed of the Auto Run scroll



Multiple Unit Power Linking

With this feature you can connect the fixtures to one another using the power cable input and output sockets. The maximum number of power linked units is 9 units @ 110V or 18 units @ 240V.

NOTE: USE CAUTION WHEN POWER LINKING OTHER FIXTURES AS THE POWER CONSUMPTION OF OTHER MODEL FIXTURES MAY EXCEED THE MAX POWER OUTPUT ON THIS FIXTURE! CHECK SILK SCREEN FOR MAX AMPS.

Master-Slave Setup

1. Using approved DMX data cables, daisy chain your units together via the XLR connector on the rear of the units. Remember the Male XLR connector is the input and the Female XLR connector is the output. The first unit in the chain (master) will use the female XLR connector only. For longer cable runs, we suggest a terminator at the last fixture.
2. Set the “Master” unit to your desired mode of operation.
3. On the “Slave” unit(s), press the UP or DOWN button (from the main menu) until “MENU Slave” is displayed. Press ENTER and set the unit to “Slave”. Each “Slave” unit must be set to the same setting.
4. Connect the first “Slave” unit to the “Master.” The “Slave” unit(s) should now start following the “Master” unit.

Installing the Frost Lens

Install the filter in front of the lens and put the included retainer ring top to hold the lens in place.

Fuse Replacement

Disconnect the unit from its power source. Remove the power cord from the unit. Once the cord has been removed, use a flat (slotted) head screwdriver to remove the fuse holder. Remove the fuse located inside the fuse holder and replace with the new fuse. Install the fuse holder and new fuse and secure it.

Cleaning

Due to fog residue, smoke, and dust cleaning the internal and external optical lenses must be carried out periodically to optimize light output.

1. Use normal glass cleaner and a soft cloth to wipe down the outside casing.
2. Clean the external optics with glass cleaner and a soft cloth every 20 days.
3. Always be sure to dry all parts completely before plugging the unit back in.

Cleaning frequency depends on the environment in which the fixture operates (i.e. smoke, fog residue, dust, dew).

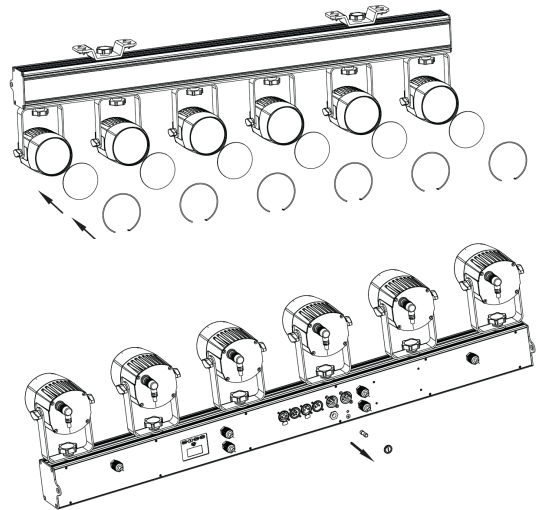

TROUBLE SHOOTING TIPS

Unit does not turn on:

- Confirm the unit has AC power.
- Check if circuit breaker that controls the AC outlet the light is plugged into is not tripped.
- Confirm the AC power cord from the light is not damaged or cut.
- Check the fuse and see if it needs to be replaced.
- If none of these solutions work, please contact ADJ Customer Service.

Unit does not respond to DMX:

- Check that the DMX cables are connected properly and are wired correctly (pin 3 is “hot”; on some other DMX devices pin 2 may be ‘hot’). Also, check that all cables are connected to the right connectors; it does matter which way the inputs and outputs are connected.

No light output in Dimmer Mode:

- Be sure that the strobe setting is set to value 255.

Unit does not respond to the remote control:

- If remote is not responding to button presses, please check battery and replace if needed.
- Ensure that RFActive mode has been turned on and is active.

FREQUENTLY ASKED QUESTIONS

Listed below are a few answers to common questions users may have.

Can the fuse be replaced?

Yes, for replacement instructions, please see page 24 for instructions.

What degree is the light beam?

Each pinspot has an ACL lens that produces a 5-degree beam. The beam angles can be adjusted using the included 10-degree or 45-degree frost filters.

What size is the battery for the RF Remote Control?

The battery is a 23A 12V battery and can be purchased from parts.adj.com

TECHNICAL SPECIFICATIONS

Power Draw:	15W x 6 (85W)
Light Source:	6x15W WW LED
Voltage:	100V ~ 240V/47~63Hz
Beam Angle:	5 Degrees
Power Cord Daisy Chain:	11 units @ 110V / 12 units @ 240V
Fuse:	T3A, 250V
CRI:	96
Color Temperature:	3,100K
DMX Channels:	3 DMX Channel Modes 1,3 and 12 Channels
Dimming:	0-100% Electronic Dimming
Strobe Rate:	1HZ-20HZ
Refresh Frequency Rate:	3,603K
Remote:	RF
IP Rating:	IP30 (Indoor Use Only)
Max Ambient Temp.	113°F (45°C)
Weight:	24.91 lbs./ 11.3Kgs.
Dimensions: (w/ bracket)	39.96" (L) x 3.76" (W) x 12.87" (H) 1,015 x 95 x 327mm
Warranty:	2 Year (730 Days)

Please Note: Specifications and improvements in the design of this unit and this manual are subject to change without any prior written notice.

Specifications subject to change without any prior written notice.

OPTIONAL ACCESSORIES

Order Code	Description
AC5PDMX3	3' DMX cable with 5-pin male to 5-pin female connection.*
AC5PDMX3PRO	Pro Series 3' DMX cable with 5-pin male to 5-pin female connection.*
S-Cable/60	Safety Cable with 60-pound weight rating
O-CLAMP	360 degree clamp that wraps around truss tubing.
PRO-CLAMP	360 degree aluminum clamp with a max rating of 1,100 lbs

*Additional lengths available at www.adj.com

DIMENSIONS

